



**BUSCH**<sup>®</sup>  
SYSTEMS



# Aristata<sup>®</sup> Series

*Recycling Has Never Looked  
So Beautiful*

**Patent: US D842,574 S**

---

Product Data Sheet | Version 1.0

Busch Systems International Inc.  
81 Rawson Avenue, Barrie ON., Canada  
1.800.565.9931  
buschsystems.com



View the Aristata<sup>®</sup> Series Online!





## RECYCLING HAS NEVER LOOKED *so beautiful*

For over five years the Aristata® Series has brought style and sophistication to recycling & waste programs across a multitude of industries. Each container is meticulously crafted to be on-trend with today's modern interiors with five stunning finishes that blend seamlessly into any space. With a variety of customization options and multiple streams in one single container, achieve outstanding diversion rates while maintaining an upscale aesthetic.



*Liners are made from 100% post-consumer recycled content*

### POPULAR SKU'S



100829



100840



100828



104145



# BUILD YOUR *Aristata*® STATION



## ONE: THE BODY

- Single
- Double
- Triple
- XL (*single, double, triple*)

## TWO: THE OPENING

- See lid opening specifications for available openings

## THREE: THE LABEL

- Choose from our stock options or customize your own!

## FOUR: OPTIONAL KITS

- Sign Frame Kits
- Wheel Caster Kits



**SINGLE**



**DOUBLE**

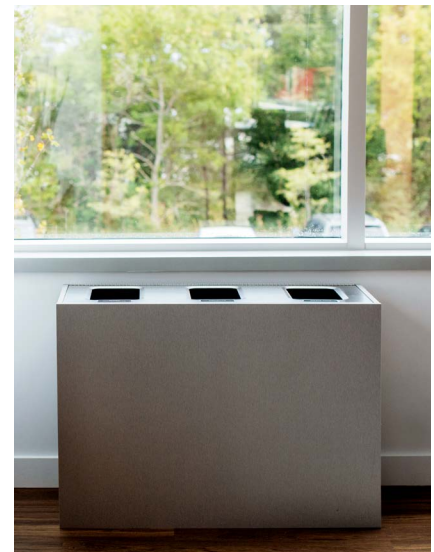

**TRIPLE**

## BODY SPECIFICATIONS

Below are the available Body Options for the Aristata® Series. With this measurement guide you will find the right size Aristata® Series container to fit your space. The measurement guide is the essence of various standard measuring methods. All measurements are in inches. The Aristata® is available in Standard & XL models of Single, Double & Triple streams. Talk to your dedicated Busch Systems® sales representative for more information on how to choose the right size container for your space.

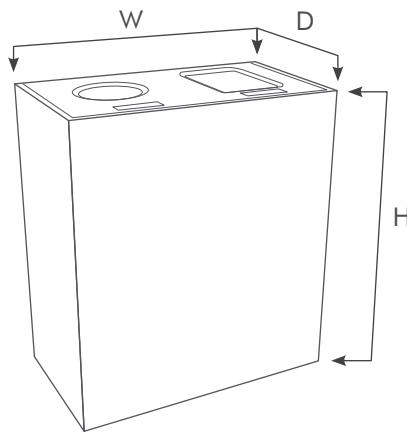

## BODIES

Body Shape	Height	Width	Depth	Weight	Capacity
Single	30"H (762mm)	15"W (381mm)	15"D (381mm)	37lbs (16.783kg)	15 gal
Double	30"H (762mm)	26.9375"W (684.213mm)	15"D (381mm)	45lbs (20.412kg)	30 gal
Triple	30"H (762mm)	39.9375"W (1014.413mm)	15"D (381mm)	65lbs (29.484kg)	45 gal
Single XL	30"H (762mm)	17.5"W (444.5mm)	21.9375"D (557.213mm)	54lbs (24.494kg)	28 gal
Double XL	30"H (762mm)	29"W (736.6mm)	21.9375"D (557.213mm)	77lbs (34.927kg)	56 gal
Triple XL	30"H (762mm)	43"W (1092.2mm)	21.9375"D (557.213mm)	106lbs (48.081kg)	84 gal

## STOCK BODY COLORS



Slate\*



Glacier

 Mid-Summer  
Flame

 Western  
Breeze

\*XL and Single configurations only stocked in Slate Finish.

## LID OPENING SPECIFICATIONS

The chart below outlines the available Lid Opening Options for each Aristata® Series model as well as the associated opening dimensions. Be sure to run a preliminary audit of the popular materials that are discarded where your Aristata® Series containers will be placed. For example, if you're collecting large quantities of standard-sized Cans & Bottles, the Circle Opening is the ideal choice, as it will reduce contamination of materials that are larger than the dimensions of the opening. If there is a blank cell on the body or lid style of your choice, this means there is currently no stock option available. Talk to your dedicated Busch Systems® sales representative for more information.

	Full
Single	
Opening Dimensions	10.25"W x 6.25"D

	Circle / Full	Mixed / Full	Full / Full
Double			
Opening Dimensions	Circle: 6"W x 6"D Full: 6.25"W x 9"D	Mixed: 2.63"W x 10.82"D x 5.25"W (circle) Full: 6.25"W x 9"D	Full (x2): 6.25"W x 9"D

	Circle / Slot / Full	Full / Full / Full
Triple		
Opening Dimensions	Circle: 6"W x 6"D Slot: 2.63"W x 10.82"D Full: 6.25"W x 9"D	Full (x3): 6.25"W x 9"D

	Single XL - Full	Double XL - Full / Full	Triple XL - Full / Full / Full
Single XL Double XL Triple XL			
Opening Dimensions	Full: 6.25"W x 9"D	Full (x2): 6.25"W x 9"D	Full (x3): 6.25"W x 9"D

## STOCK LID COLORS



Stainless Steel

## PRODUCT ACCESSORIES

If you're interested in maximizing the full potential of your Aristata® Series containers, you can enhance the quality & performance and expand the possibilities with top quality accessories that will add functionality and convenience with ease. These product accessories are designed to help you get the most out of your recycling & waste management equipment. Busch Systems® offers a number of different accessories to add convenience and portability.

To add movement to your Aristata® Series station, consider the Busch Systems® professional quality caster kits that allow you to easily move your station to a better location or for cleaning and maintenance.

For more customization, many of the Aristata® Series models are compatible with a vast choice of customizable sign frame and signage options that increase stream visibility.

### SIGN FRAMES

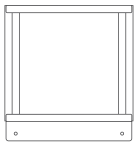

**SINGLE**  
(fits 13"x11.75" sign)

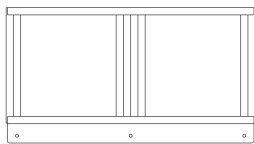

**DOUBLE**  
(fits two 13"x11.75" signs)

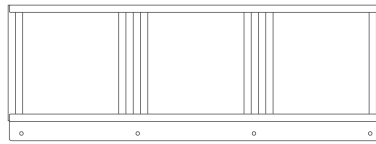

**TRIPLE**  
(fits three 13"x11.75" signs)

### CASTERS

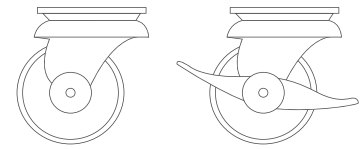

2 FREE + 2 LOCKING

\*Wheel Caster Kits not available for XL Configurations.

## STOCK LABELS & OPTIONAL SIGNS

Labels come standard with a black background and white text. These premium labels incorporate a glossy 3D coating which adds to the high-end look of the Aristata®. All labels are able to be customized. These optional signs come standard with a black background and white text. All signs can be customized to match your unique branding and stream requirements.

### STOCK LABELS



### OPTIONAL SIGNS

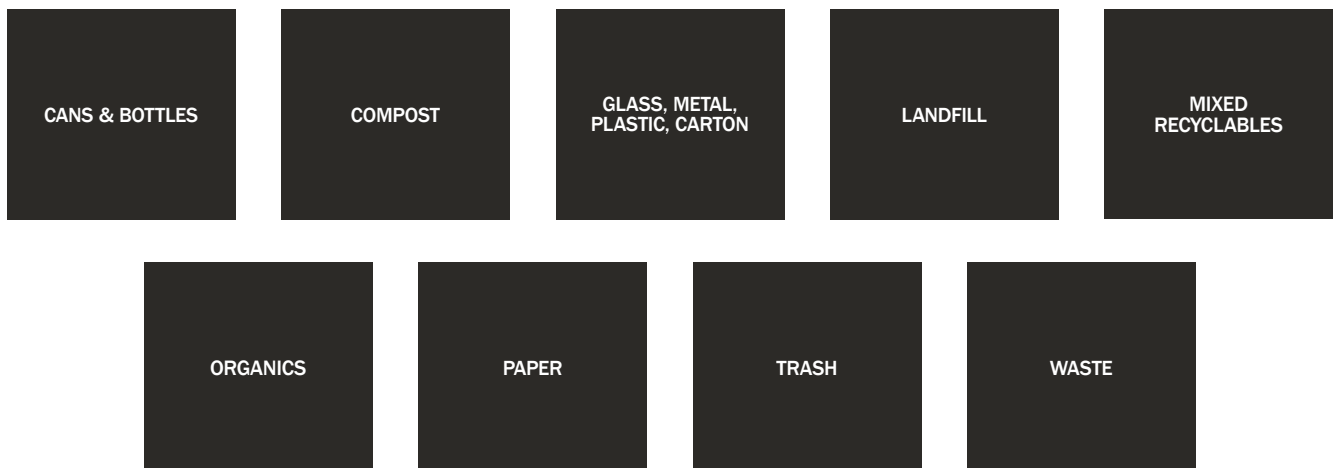

NOTE: Because different computers, monitors, and printers render colors and textures differently, actual finishes may vary from those shown here.

## IDEAL BAG SIZES

	Single / Double / Triple	Single XL / Double XL / Triple XL	Double Lid - Solid Lift
Ideal Bag Size (inches)	25 x 36	32 x 35	32 x 35

## MATERIAL & CONSTRUCTION DETAILS

Not all recycling & waste receptacles are created equal. Our company policy is never to compromise on our workmanship or the quality material standards we've set. We only recommend and use quality first grade materials on our recycling & waste containers, and source these from OEM's at highly-competitive prices. Being a manufacturer that buys at high-quantities gives significant buying power with companies which in turn saves you money.

The design process, materials used, finishes and manufacturing standards all affect the final product. Every decision is vital to getting the most value for your investment. You deserve recycling & waste containers that meets your demands for quality and durability and will enhance your working environment for years to come.

Component	Material(s)	Construction
Bodies	Coated Composite Board	<ul style="list-style-type: none"> <li>High-density &amp; moisture resistant with excellent dimensional stability</li> </ul>
Lids	Stainless Steel	<ul style="list-style-type: none"> <li>18 Gauge 304 #4 Finish</li> </ul>
Liners	HDPE	<ul style="list-style-type: none"> <li>Made of 100% post-consumer recycled material</li> </ul>
Sign Frames	Powder Coated Steel	<ul style="list-style-type: none"> <li>Fire-safe steel construction</li> </ul>
Signage	100lb. Digital Cover Coated Paper	<ul style="list-style-type: none"> <li>30% PCW FSC®</li> </ul>
Casters	Steel	<ul style="list-style-type: none"> <li>Available sets include 4 durable, long-lasting swivel casters (2 of 4 casters include brakes to secure container into place)</li> </ul>

## ENVIRONMENTAL CONSIDERATIONS

- All Aristata® Receptacles use a low energy, resource efficient manufacturing and curing process
- All Aristata® receptacle components disassemble at end of life and are fully recyclable
- Low maintenance and extremely long service life
- Manufactured in North America

Configurations	Post-Industrial Recycled Content	Post-Consumer Recycled Content	Total Recycled Content	3rd Party Certifications
Aristata®	Contact us	Contact us	Contact us	-

Busch Systems® is dedicated to environmental responsibility. We maintain an Environmental Management System and are continually working to improve our impact through efficiency, material selection, vendor education, employee involvement, and an unwavering commitment to being a B-Corporation®. If you would like additional information on our product development process or if you don't see the information you need for your project on this page, please contact our Sustainability Team at [sustainability@buschsystems.com](mailto:sustainability@buschsystems.com).

## LEAD TIME

Our standard lead times on the Aristata® Series are 2-3 weeks, and 6-8 weeks on custom or large orders. Please contact us to discuss your specific timing requirements.

## PRICING

Please contact us at **800.565.9931** or **sales@buschsystems.com**. At Busch Systems®, we design, manufacture and sell our products directly to you. Our sales team is available to assist you with questions about our products, requests for quotes, and orders. Vertical Managers are located across North America to assist with the front-end specification and quoting process, and our in-house Project Sales Coordinators follow your project through from the time you place an order to shipment.

## TO ORDER PLEASE SPECIFY

Quantity, body model, lid model, label choice and any optional product accessories. Talk to your dedicated Busch Systems® sales representative for more information. If you do not have a dedicated Sales Representative please contact us via our website at **buschsystems.com/contact-us/**

## INSTALLATION

Busch Systems® Aristata® Series containers are hassle-free when it comes to installation. Each container comes fully-assembled and individually boxed using high-density cardboard with high-recycled content to ensure safe and environmentally friendly transport.

### TO INSTALL YOUR ARISTATA® SERIES CONTAINERS:

1. Unbox each station and remove (peel) the protective coating from the stainless steel lid by hand
2. Apply your chosen labels
3. (optional) Assemble the powder-coated steel signage. 2 persons and tools required.
4. Insert the recycling/waste bag into each liner and wrap the top edge of the bag around the liner.

## CARE & MAINTENANCE

Advantages of Busch Systems Composite Board receptacles include:

- Highly-durable material and is able to withstand physical stress to a greater degree than wood.
- Minor dings and scratches are much less likely to bend your containers out of shape or leave the finished scratched.
- More moisture and heat resistant when compared to wood, allowing for them to better stand up to the stress associated with heavy use.

Their appearance and lifespan will be greatly affected by their care. The frequency of cleaning required depends on the environment in which the containers are used. The Aristata® Series is intended for Indoor Use Only.

To avoid the accumulation of dirt and grime on your Busch Systems products, and help prevent corrosion, we recommend that a mild detergent be used (not an abrasive), such as a pH-neutral liquid (hand dishwashing or hand car washing soaps, for example) diluted in warm water. Rinse well with clean water. Any dirt adhering to the powder coating should be removed. In order to remove deposits such as salt or dust, use a soft brush (non-abrasive). If this is not sufficient to remove stubborn soiling, the following products have been tested for use:

- Ajax Cream
- Liquid Gumption
- Flash (in water)
- Ajax Liquid (in water)
- Cutting compound ('T. Cut')

**Note:** Always test soaps/cleaners on a hidden and/or small area beforehand

If solvents are absolutely needed to remove marks, a soft cloth dampened with white spirit may be used.

## GENERAL CARE

- Clean with a mild detergent and damp sponge or cloth
- For tougher cleaning purposes, Lysol, TSP or Spray Nine may be used
- To remove permanent marker on melamine, use a small amount of Lacquer Thinner or Acetone on a cotton rag

## THINGS TO AVOID

- Cleaners with chloride or bleach
- Strong Solvents
- Abrasive detergents
- Steel wool or Scouring pads
- Trapped moisture between product and things like rubber mats



**Contact Us Today for a Quote on Your Aristata® Station!**



**BUSCH®**  
SYSTEMS

Certified



Corporation